

Relay Module - RIF-1-RPT-LV-24AC/2X21 - 2903333

Please be informed that the data shown in this PDF Document is generated from our Online Catalog. Please find the complete data in the user's documentation. Our General Terms of Use for Downloads are valid (<http://phoenixcontact.com/download>)



Pre-assembled relay module with push-in connection, consisting of: relay base, power contact relay, plug-in display/suppressor module, and retaining bracket. Contact type: 2 PDTs. Input voltage: 24 V AC

Product Description

The pluggable electromechanical and solid-state relays in the RIFLINE complete product range and the base are recognized and approved in accordance with UL 508. The relevant approvals can be called up at the individual components in question.



Key Commercial Data

| | |
|--------------|---|
| Packing unit | 10 pc |
| GTIN |  4 046356 732284 |
| GTIN | 4046356732284 |

Technical data

Note

| | |
|-------------------------|---|
| Utilization restriction | EMC: class A product, see manufacturer's declaration in the download area |
| Type of note | Notes on operation |
| Note | FBS 2-6... plug-in bridge for the input side (A2) and FBS-2-8... plug-in bridge for the output side (11/21) |

Dimensions

| | |
|--------|-------|
| Width | 16 mm |
| Height | 93 mm |
| Depth | 75 mm |

Ambient conditions

| | |
|---|-------------------|
| Ambient temperature (operation) | -40 °C ... 50 °C |
| Ambient temperature (storage/transport) | -40 °C ... 85 °C |
| Degree of protection | IP20 (Relay base) |
| | RT III (Relay) |

Relay Module - RIF-1-RPT-LV-24AC/2X21 - 2903333

Technical data

Coil side

| | |
|---|----------------|
| Nominal input voltage U_N | 24 V AC |
| Input voltage range in reference to U_N | see diagram |
| Mains frequency | 50/60 Hz |
| Typical input current at U_N | 33 mA |
| Typical response time | 3 ms ... 12 ms |
| Typical release time range | 3 ms ... 20 ms |
| Coil voltage | 24 V AC |
| Protective circuit | Varistor |
| Operating voltage display | Yellow LED |
| Power dissipation for nominal condition | 0.79 W |

Contact side

| | |
|---------------------------------------|----------------------------|
| Contact type | 2 PDT |
| Type of switch contact | Single contact |
| Contact material | AgNi |
| Maximum switching voltage | 250 V AC/DC |
| Minimum switching voltage | 5 V (at 10 mA) |
| Min. switching current | 10 mA (At 5 V) |
| Maximum inrush current | 12 A (20 ms, N/O contacts) |
| Limiting continuous current | 8 A (see diagram) |
| Interrupting rating (ohmic load) max. | 192 W (at 24 V DC) |
| | 96 W (at 48 V DC) |
| | 60 W (at 60 V DC) |
| | 44 W (at 110 V DC) |
| | 57 W (at 220 V DC) |
| | 2000 VA (for 250 V AC) |
| Switching capacity | 2 A (at 24 V, DC13) |
| | 0.2 A (at 250 V, DC13) |
| | 3 A (at 24 V, AC15) |
| | 3 A (at 120 V, AC15) |
| | 3 A (at 250 V, AC15) |

General

| | |
|--|---------------------------------------|
| Test voltage relay winding/relay contact | 4 kV _{rms} (50 Hz, 1 min.) |
| Test voltage PDT/PDT | 2.5 kV _{rms} (50 Hz, 1 min.) |
| Operating mode | 100% operating factor |
| Flammability rating according to UL 94 | V2 (Housing) |
| Mechanical service life | approx. 10^7 cycles |
| Service life, electrical | see diagram |
| Mounting position | any |
| Assembly instructions | In rows with zero spacing |

Relay Module - RIF-1-RPT-LV-24AC/2X21 - 2903333

Technical data

Connection data

| | |
|----------------------------------|---|
| Connection name | Coil side |
| Connection method | Push-in connection |
| Stripping length | 8 mm |
| Conductor cross section solid | 0.14 mm ² ... 1.5 mm ² |
| Conductor cross section flexible | 0.14 mm ² ... 1.5 mm ² |
| | 0.14 mm ² ... 1.5 mm ² (Ferrule with plastic sleeve) |
| | 0.14 mm ² ... 1 mm ² (Ferrule with plastic sleeve, two conductors on double terminal block) |
| Conductor cross section AWG | 26 ... 16 (solid) |
| | 26 ... 16 (flexible) |

Connection data 2

| | |
|----------------------------------|---|
| Connection name | Contact side |
| Connection method | Push-in connection |
| Stripping length | 8 mm |
| Conductor cross section solid | 0.14 mm ² ... 1.5 mm ² |
| Conductor cross section flexible | 0.14 mm ² ... 1.5 mm ² |
| | 0.14 mm ² ... 1.5 mm ² (Ferrule with plastic sleeve) |
| | 0.14 mm ² ... 1 mm ² (Ferrule with plastic sleeve, two conductors on double terminal block) |
| Conductor cross section AWG | 26 ... 16 (solid) |
| | 26 ... 16 (flexible) |

Standards and Regulations

| | |
|-----------------------|---|
| Standards/regulations | DIN EN 50178 |
| Rated surge voltage | 6 kV |
| Insulation | Safe isolation, basic insulation, and 4 kV rated surge voltage between all changeover contacts. |
| Pollution degree | 2 |
| Overvoltage category | III |

Environmental Product Compliance

| | |
|------------|---|
| China RoHS | Environmentally Friendly Use Period = 50 years |
| | For details about hazardous substances go to tab "Downloads", Category "Manufacturer's declaration" |

Drawings

Relay Module - RIF-1-RPT-LV-24AC/2X21 - 2903333

Circuit diagram

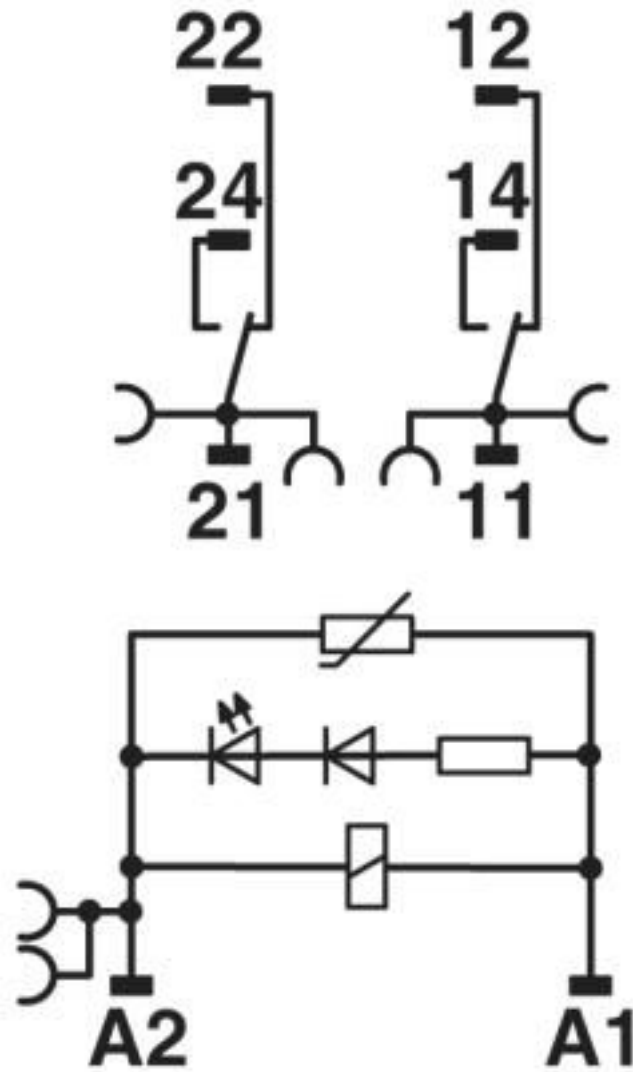

AC coils

Relay Module - RIF-1-RPT-LV-24AC/2X21 - 2903333

Diagram

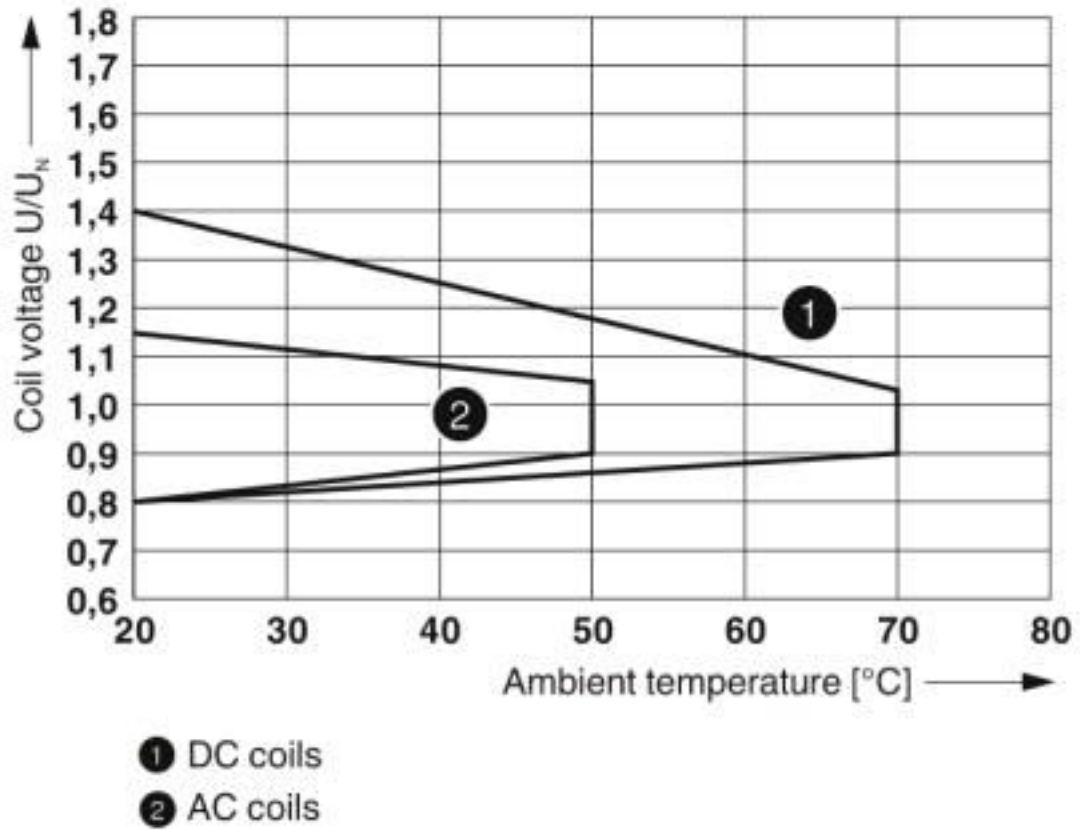

Operating voltage range

Relay Module - RIF-1-RPT-LV-24AC/2X21 - 2903333

Diagram

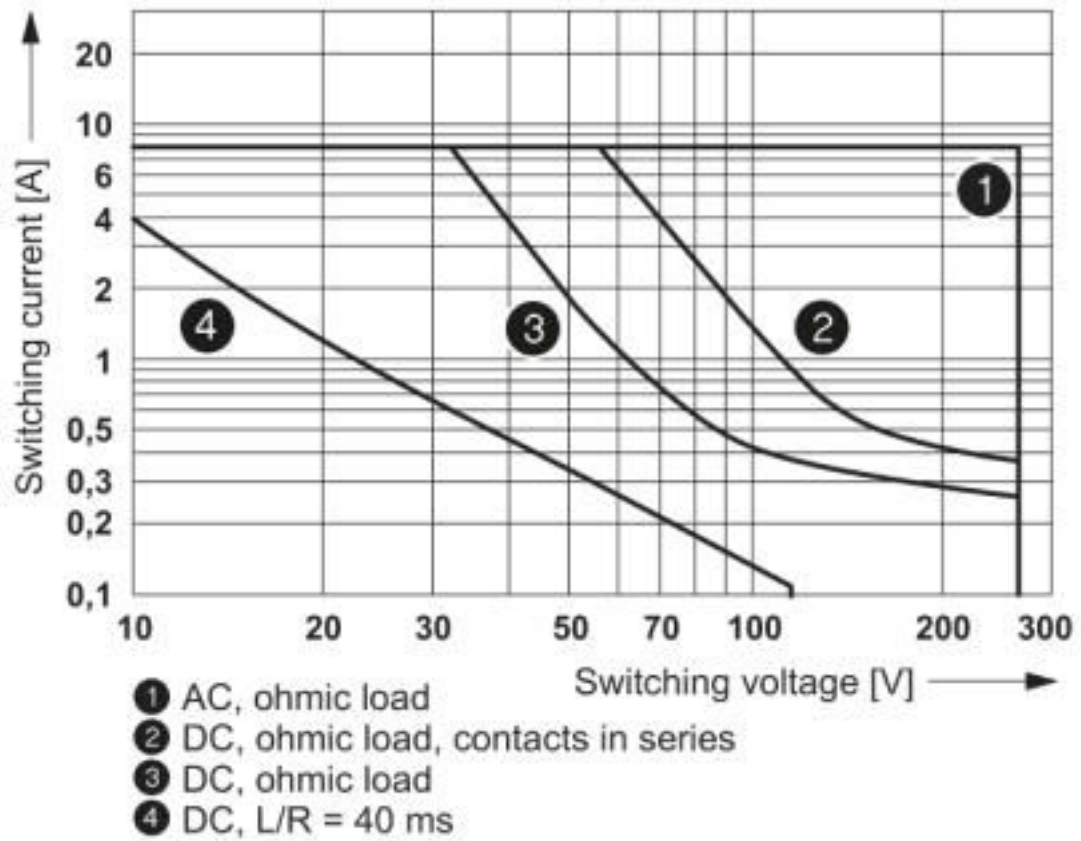

Interrupting rating

Relay Module - RIF-1-RPT-LV-24AC/2X21 - 2903333

Diagram

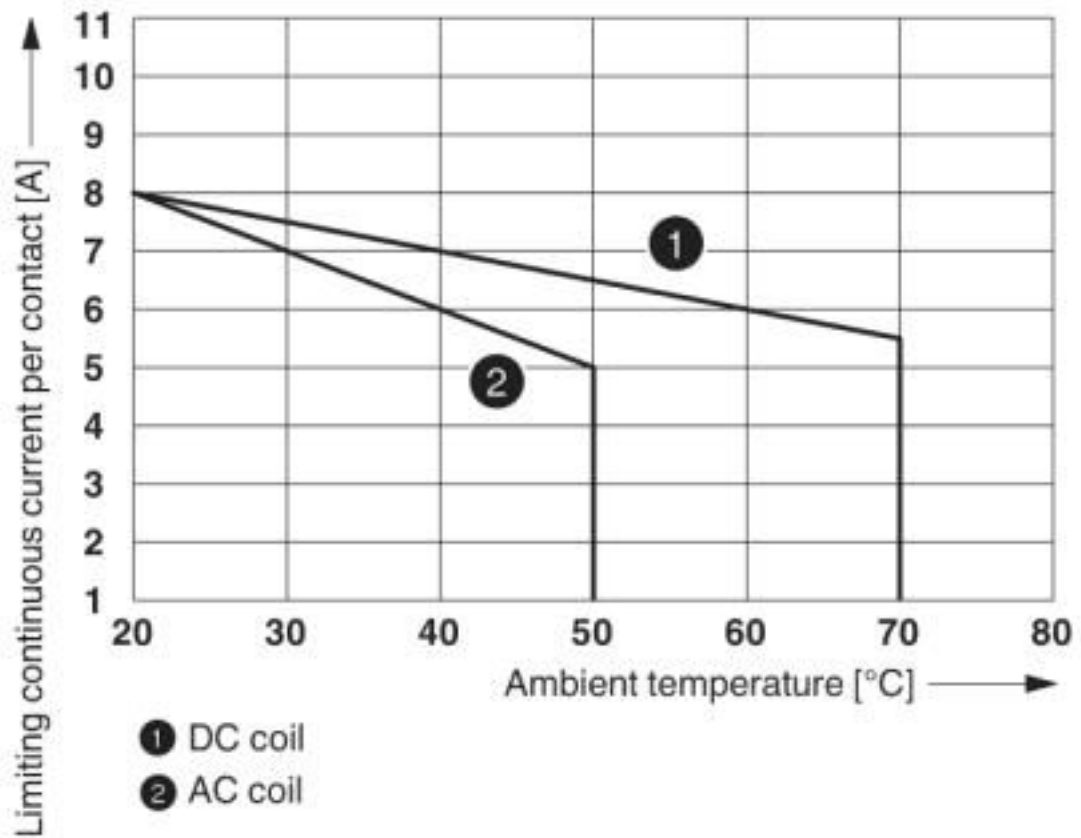

Contact derating

Relay Module - RIF-1-RPT-LV-24AC/2X21 - 2903333

Diagram

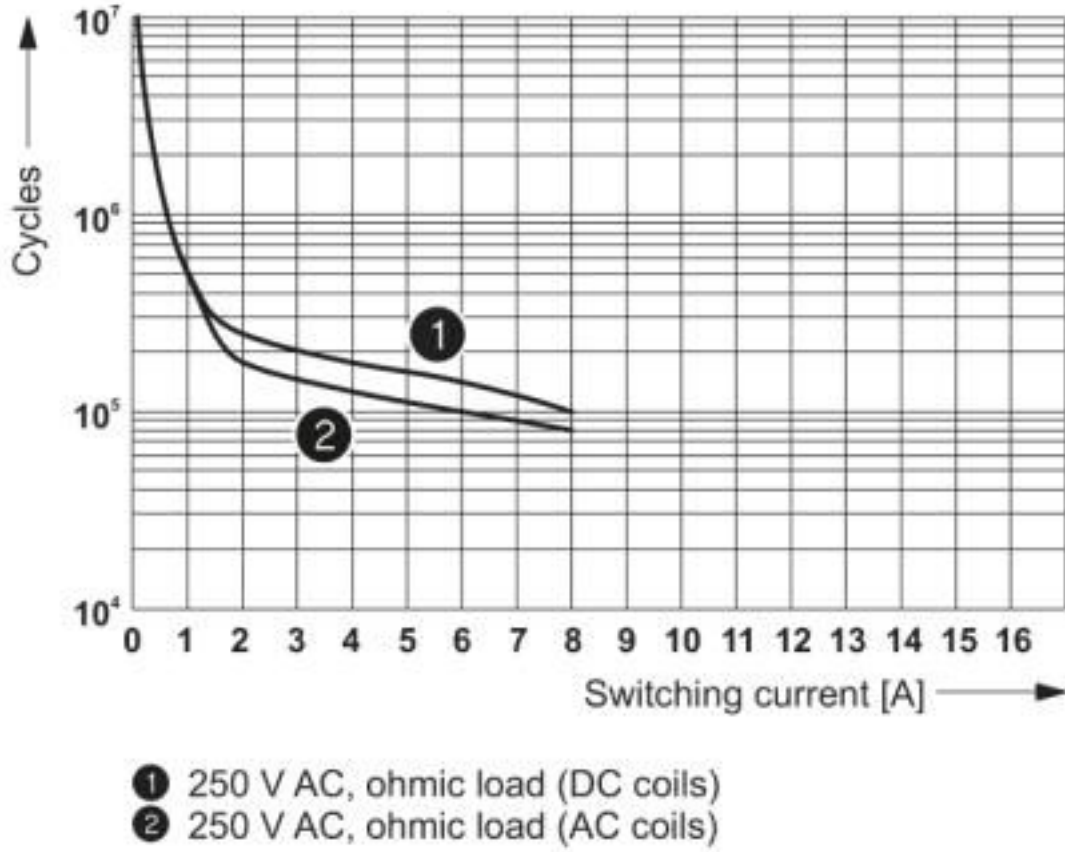

Electrical service life

Relay Module - RIF-1-RPT-LV-24AC/2X21 - 2903333

Diagram

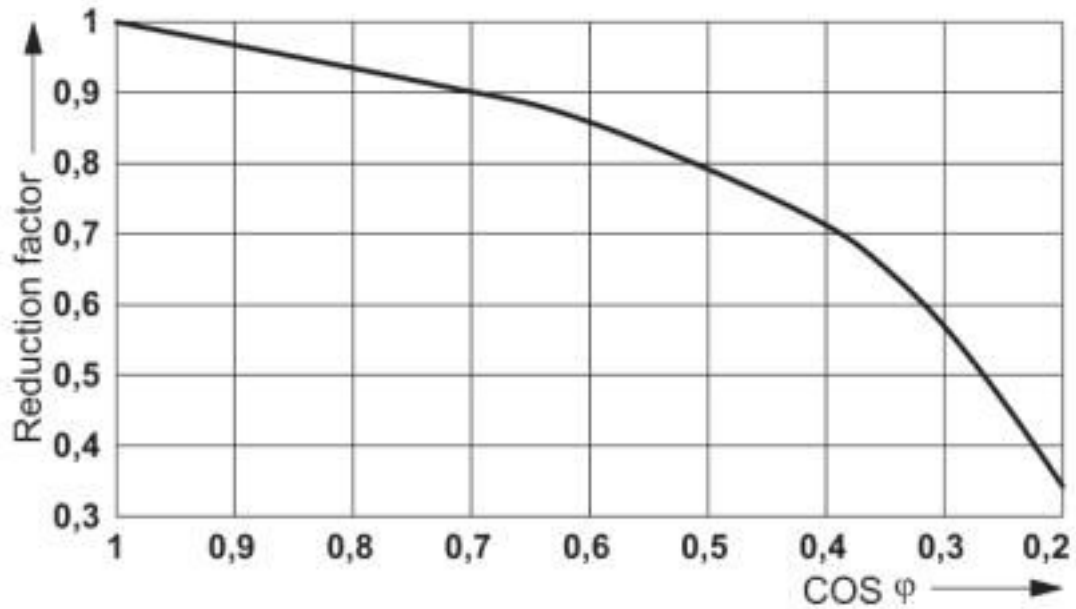

Service life reduction factor

Articles in set

Relay base - RIF-1-BPT/2X21 - 2900931



RIF-1... relay base, for miniature power relay with 1 or 2 PDTs or solid-state relays of the same design, push-in connection, plug-in option for input/suppressor modules, for mounting on NS 35/7,5

Single relay - REL-MR- 24AC/21-21 - 2961435



Plug-in miniature power relay, with power contact, 2 PDTs, input voltage 24 V AC

Plug-in module - RIF-LV-12-24 UC - 2900942



Plug-in module, for mounting on RIF-1, RIF-2, RIF-3, and RIF-4, with varistor and yellow LED, input voltage: 12 ... 24 V AC/DC $\pm 20\%$

Relay Module - RIF-1-RPT-LV-24AC/2X21 - 2903333

Articles in set

Retaining bracket - RIF-RH-1 - 2900953



Relay retaining bracket, with ejector function and holder for marking material, suitable for RIF-1 relay base, for 16 mm tall miniature power relay and solid-state relay

Classifications

eCl@ss

| | |
|---------------|----------|
| eCl@ss 10.0.1 | 27371601 |
| eCl@ss 11.0 | 27371601 |
| eCl@ss 4.0 | 27371100 |
| eCl@ss 4.1 | 27371100 |
| eCl@ss 5.0 | 27371600 |
| eCl@ss 5.1 | 27371600 |
| eCl@ss 6.0 | 27371600 |
| eCl@ss 7.0 | 27371601 |
| eCl@ss 8.0 | 27371601 |
| eCl@ss 9.0 | 27371601 |

ETIM

| | |
|----------|----------|
| ETIM 2.0 | EC001437 |
| ETIM 3.0 | EC001437 |
| ETIM 4.0 | EC001437 |
| ETIM 5.0 | EC001437 |
| ETIM 6.0 | EC001437 |
| ETIM 7.0 | EC001437 |

UNSPSC

| | |
|---------------|----------|
| UNSPSC 6.01 | 30211916 |
| UNSPSC 7.0901 | 39121515 |
| UNSPSC 11 | 39121515 |
| UNSPSC 12.01 | 39121515 |
| UNSPSC 13.2 | 39122334 |
| UNSPSC 18.0 | 39122334 |
| UNSPSC 19.0 | 39122334 |
| UNSPSC 20.0 | 39122334 |
| UNSPSC 21.0 | 39122334 |

Approvals

Approvals

Relay Module - RIF-1-RPT-LV-24AC/2X21 - 2903333





Approvals

Approvals

DNV GL / PRS / LR / EAC / DNV GL

Ex Approvals

Approval details

| | | | |
|--------|---|---|-------------------|
| DNV GL |  | https://approvalfinder.dnvgl.com/ | TAA000018V |
| PRS |  | http://www.prs.pl/ | TE/2108/880590/16 |
| LR |  | http://www.lr.org/en | 15/20011 |
| EAC |  | | TR_TS_D_00573_c |
| DNV GL |  | https://approvalfinder.dnvgl.com/ | TAA000018V |

Accessories

Accessories

DIN rail

DIN rail perforated - NS 35/ 7,5 PERF 2000MM - 0801733



DIN rail perforated, Standard profile, width: 35 mm, height: 7.5 mm, acc. to EN 60715, material: Steel, galvanized, passivated with a thick layer, length: 2000 mm, color: silver

Relay Module - RIF-1-RPT-LV-24AC/2X21 - 2903333

Accessories

DIN rail, unperforated - NS 35/ 7,5 UNPERF 2000MM - 0801681



DIN rail, unperforated, Standard profile, width: 35 mm, height: 7.5 mm, acc. to EN 60715, material: Steel, galvanized, passivated with a thick layer, length: 2000 mm, color: silver

DIN rail perforated - NS 35/ 7,5 WH PERF 2000MM - 1204119



DIN rail perforated, Standard profile, width: 35 mm, height: 7.5 mm, acc. to EN 60715, material: Steel, Galvanized, white passivated, length: 2000 mm, color: silver

DIN rail, unperforated - NS 35/ 7,5 WH UNPERF 2000MM - 1204122



DIN rail, unperforated, Standard profile, width: 35 mm, height: 7.5 mm, acc. to EN 60715, material: Steel, Galvanized, white passivated, length: 2000 mm, color: silver

DIN rail, unperforated - NS 35/ 7,5 AL UNPERF 2000MM - 0801704



DIN rail, unperforated, Standard profile, width: 35 mm, height: 7.5 mm, acc. to EN 60715, material: Aluminum, uncoated, length: 2000 mm, color: silver

DIN rail perforated - NS 35/ 7,5 ZN PERF 2000MM - 1206421



DIN rail perforated, Standard profile, width: 35 mm, height: 7.5 mm, acc. to EN 60715, material: Steel, galvanized, length: 2000 mm, color: silver

Relay Module - RIF-1-RPT-LV-24AC/2X21 - 2903333

Accessories

DIN rail, unperforated - NS 35/ 7,5 ZN UNPERF 2000MM - 1206434



DIN rail, unperforated, Standard profile, width: 35 mm, height: 7.5 mm, acc. to EN 60715, material: Steel, galvanized, length: 2000 mm, color: silver

DIN rail, unperforated - NS 35/ 7,5 CU UNPERF 2000MM - 0801762



DIN rail, unperforated, Standard profile, width: 35 mm, height: 7.5 mm, acc. to EN 60715, material: Copper, uncoated, length: 2000 mm, color: copper-colored

End cap - NS 35/ 7,5 CAP - 1206560



DIN rail end piece, for DIN rail NS 35/7.5

DIN rail perforated - NS 35/15 PERF 2000MM - 1201730



DIN rail perforated, Standard profile, width: 35 mm, height: 15 mm, similar to EN 60715, material: Steel, galvanized, passivated with a thick layer, length: 2000 mm, color: silver

DIN rail, unperforated - NS 35/15 UNPERF 2000MM - 1201714



DIN rail, unperforated, Standard profile, width: 35 mm, height: 15 mm, similar to EN 60715, material: Steel, galvanized, passivated with a thick layer, length: 2000 mm, color: silver

Relay Module - RIF-1-RPT-LV-24AC/2X21 - 2903333

Accessories

DIN rail perforated - NS 35/15 WH PERF 2000MM - 0806602



DIN rail perforated, Standard profile, width: 35 mm, height: 15 mm, similar to EN 60715, material: Steel, Galvanized, white passivated, length: 2000 mm, color: silver

DIN rail, unperforated - NS 35/15 WH UNPERF 2000MM - 1204135



DIN rail, unperforated, Standard profile, width: 35 mm, height: 15 mm, similar to EN 60715, material: Steel, Galvanized, white passivated, length: 2000 mm, color: silver

DIN rail, unperforated - NS 35/15 AL UNPERF 2000MM - 1201756



DIN rail, unperforated, Standard profile, width: 35 mm, height: 15 mm, similar to EN 60715, material: Aluminum, uncoated, length: 2000 mm, color: silver

DIN rail perforated - NS 35/15 ZN PERF 2000MM - 1206599



DIN rail perforated, Standard profile, width: 35 mm, height: 15 mm, similar to EN 60715, material: Steel, galvanized, length: 2000 mm, color: silver

DIN rail, unperforated - NS 35/15 ZN UNPERF 2000MM - 1206586



DIN rail, unperforated, Standard profile, width: 35 mm, height: 15 mm, similar to EN 60715, material: Steel, galvanized, length: 2000 mm, color: silver

Relay Module - RIF-1-RPT-LV-24AC/2X21 - 2903333

Accessories

DIN rail, unperforated - NS 35/15 CU UNPERF 2000MM - 1201895



DIN rail, unperforated, Standard profile, width: 35 mm, height: 15 mm, similar to EN 60715, material: Copper, uncoated, length: 2000 mm, color: copper-colored

End cap - NS 35/15 CAP - 1206573



DIN rail end piece, for DIN rail NS 35/15

DIN rail, unperforated - NS 35/15-2,3 UNPERF 2000MM - 1201798



DIN rail, unperforated, Standard profile 2.3 mm, width: 35 mm, height: 15 mm, acc. to EN 60715, material: Steel, galvanized, passivated with a thick layer, length: 2000 mm, color: silver

End block

End clamp - CLIPFIX 35 - 3022218



Quick mounting end clamp for NS 35/7,5 DIN rail or NS 35/15 DIN rail, with marking option, width: 9.5 mm, color: gray

End clamp - CLIPFIX 35-5 - 3022276



Quick mounting end clamp for NS 35/7,5 DIN rail or NS 35/15 DIN rail, with marking option, with parking option for FBS...5, FBS...6, KSS 5, KSS 6, width: 5.15 mm, color: gray

Relay Module - RIF-1-RPT-LV-24AC/2X21 - 2903333

Accessories

End clamp - E/NS 35 N - 0800886



End clamp, width: 9.5 mm, color: gray

Insulating sleeve

Insulating sleeve - MPS-IH WH - 0201663

Insulating sleeve, color: white



Insulating sleeve - MPS-IH RD - 0201676

Insulating sleeve, color: red



Insulating sleeve - MPS-IH BU - 0201689

Insulating sleeve, color: blue



Insulating sleeve - MPS-IH YE - 0201692

Insulating sleeve, color: yellow



Relay Module - RIF-1-RPT-LV-24AC/2X21 - 2903333

Accessories

Insulating sleeve - MPS-IH GN - 0201702

Insulating sleeve, color: green



Insulating sleeve - MPS-IH GY - 0201728

Insulating sleeve, color: gray



Insulating sleeve - MPS-IH BK - 0201731

Insulating sleeve, color: black



Jumper

Plug-in bridge - FBS 2-6 - 3030336



Plug-in bridge, pitch: 6.2 mm, width: 10.7 mm, number of positions: 2, color: red

Plug-in bridge - FBS 2-6 BU - 3036932



Plug-in bridge, pitch: 6.2 mm, width: 10.7 mm, number of positions: 2, color: blue

Relay Module - RIF-1-RPT-LV-24AC/2X21 - 2903333

Accessories

Plug-in bridge - FBS 2-6 GY - 3032237



Plug-in bridge, pitch: 6.2 mm, width: 10.7 mm, number of positions: 2, color: gray

Plug-in bridge - FBS 2-8 - 3030284



Plug-in bridge, pitch: 8.2 mm, width: 14.7 mm, number of positions: 2, color: red

Plug-in bridge - FBS 2-8 BU - 3032567



Plug-in bridge, pitch: 8.2 mm, width: 14.7 mm, number of positions: 2, color: blue

Plug-in bridge - FBS 2-8 GY 7042 - 3032541



Bridge for potential distribution

Labeled terminal marker

Zack marker strip - ZB 5 CUS - 0824962



Zack marker strip, can be ordered: Strip, white, labeled according to customer specifications, mounting type: snap into tall marker groove, for terminal block width: 5.2 mm, lettering field size: 5.15 x 10.5 mm, Number of individual labels: 10

Relay Module - RIF-1-RPT-LV-24AC/2X21 - 2903333

Accessories

Zack marker strip - ZB 5,LGS:FORTL.ZAHLEN - 1050017



Zack marker strip, Strip, white, labeled, printed horizontally: consecutive numbers 1 ... 10, 11 ... 20, etc. up to 491 ... 500, mounting type: snap into tall marker groove, for terminal block width: 5.2 mm, lettering field size: 5.15 x 10.5 mm, Number of individual labels: 10

Zack marker strip - ZB 5,QR:FORTL.ZAHLEN - 1050020



Zack marker strip, white, Printed vertically: consecutive numbers 1 ... 10, 11 ... 20, etc. up to 491 ... 500, mounting type: snap into tall marker groove, for terminal block width: 5.2 mm, lettering field size: 5.15 x 10.5 mm

Zack marker strip - ZB 5,LGS:GLEICHE ZAHLEN - 1050033



Zack marker strip, Strip, white, labeled, can be labeled with: CMS-P1-PLOTTER, printed horizontally: Identical numbers 1 or 2, etc. up to 100, mounting type: snap into tall marker groove, for terminal block width: 5.2 mm, lettering field size: 5.15 x 10.5 mm, Number of individual labels: 10

Zack marker strip - ZB 5,LGS:L1-N,PE - 1050415



Zack marker strip, Strip, white, labeled, horizontal: L1, L2, L3, N, PE, L1, L2, L3, N, PE, mounting type: snap into tall marker groove, for terminal block width: 5.2 mm, lettering field size: 5.15 x 10.5 mm, Number of individual labels: 10

Marker for terminal blocks - UC-TM 5 CUS - 0824581



Marker for terminal blocks, can be ordered: by sheet, white, labeled according to customer specifications, mounting type: snap into tall marker groove, for terminal block width: 5.2 mm, lettering field size: 10.5 x 4.6 mm, Number of individual labels: 96

Relay Module - RIF-1-RPT-LV-24AC/2X21 - 2903333

Accessories

Marker for terminal blocks - UCT-TM 5 CUS - 0829595



Marker for terminal blocks, can be ordered: by sheet, white, labeled according to customer specifications, mounting type: snap into tall marker groove, for terminal block width: 5.2 mm, lettering field size: 4.6 x 10.5 mm, Number of individual labels: 72

Zack marker strip - ZB 15 CUS - 0824945



Zack marker strip, can be ordered: Strip, white, labeled according to customer specifications, mounting type: snap into tall marker groove, for terminal block width: 15.2 mm, lettering field size: 10.5 x 15.1 mm, Number of individual labels: 5

Zack marker strip - ZB 15,LGS:L1-N,PE - 0811998



Zack marker strip, Strip, white, labeled, printed horizontally: L1, L2, L3, N, PE, mounting type: snap into tall marker groove, for terminal block width: 15.2 mm, lettering field size: 10.5 x 15.1 mm, Number of individual labels: 5

Marker carriers

Marker carriers - STP 5-2 - 0800967



Double marker carrier, snaps onto the double-level spring-cage terminal block STTB 2,5, STTB 4, PTTB 2,5, PTTB 4 can be marked with UC-TM 5, ZB 5 or UC-TMF 5, ZBF 5

Terminal marking

Marker for terminal blocks - UC-TM 16 - 0819217



Marker for terminal blocks, Sheet, white, unlabeled, can be labeled with: BLUEMARK ID COLOR, BLUEMARK ID, BLUEMARK CLED, PLOTMARK, CMS-P1-PLOTTER, mounting type: snap into tall marker groove, for terminal block width: 16 mm, lettering field size: 15.45 x 10.5 mm, Number of individual labels: 32

Relay Module - RIF-1-RPT-LV-24AC/2X21 - 2903333

Accessories

Marker for terminal blocks - UC-TMF 16 - 0819262



Marker for terminal blocks, Sheet, white, unlabeled, can be labeled with: BLUEMARK ID COLOR, BLUEMARK ID, BLUEMARK CLED, PLOTMARK, CMS-P1-PLOTTER, mounting type: snap into flat marker groove, for terminal block width: 16 mm, lettering field size: 15.45 x 5.1 mm, Number of individual labels: 32

Zack marker strip - ZB 5 :UNBEDRUCKT - 1050004



Zack marker strip, Strip, white, unlabeled, can be labeled with: PLOTMARK, CMS-P1-PLOTTER, mounting type: snap into tall marker groove, for terminal block width: 5.2 mm, lettering field size: 5.1 x 10.5 mm, Number of individual labels: 10

Marker for terminal blocks - UC-TM 5 - 0818108



Marker for terminal blocks, Sheet, white, unlabeled, can be labeled with: BLUEMARK ID COLOR, BLUEMARK ID, BLUEMARK CLED, PLOTMARK, CMS-P1-PLOTTER, mounting type: snap into tall marker groove, for terminal block width: 5.2 mm, lettering field size: 10.5 x 4.6 mm, Number of individual labels: 96

Marker for terminal blocks - UCT-TM 5 - 0828734



Marker for terminal blocks, Sheet, white, unlabeled, can be labeled with: TOPMARK NEO, TOPMARK LASER, BLUEMARK ID COLOR, BLUEMARK ID, BLUEMARK CLED, THERMOMARK PRIME, THERMOMARK CARD 2.0, THERMOMARK CARD, mounting type: snap into tall marker groove, for terminal block width: 5.2 mm, lettering field size: 4.6 x 10.5 mm, Number of individual labels: 72

Zack marker strip - ZB 15:UNBEDRUCKT - 0811972



Zack marker strip, Strip, white, unlabeled, can be labeled with: PLOTMARK, CMS-P1-PLOTTER, mounting type: snap into tall marker groove, for terminal block width: 15.2 mm, lettering field size: 10.5 x 15.1 mm, Number of individual labels: 5

Test plug terminal block

Relay Module - RIF-1-RPT-LV-24AC/2X21 - 2903333

Accessories

Test plugs - MPS-MT - 0201744



Test plugs, with solder connection up to 1 mm² conductor cross section, color: gray

Spare parts

Relay base - RIF-1-BPT/2X21 - 2900931



RIF-1... relay base, for miniature power relay with 1 or 2 PDTs or solid-state relays of the same design, push-in connection, plug-in option for input/suppressor modules, for mounting on NS 35/7,5

Single relay - REL-MR- 24AC/21-21 - 2961435



Plug-in miniature power relay, with power contact, 2 PDTs, input voltage 24 V AC

Plug-in module - RIF-LV-12-24 UC - 2900942



Plug-in module, for mounting on RIF-1, RIF-2, RIF-3, and RIF-4, with varistor and yellow LED, input voltage: 12 ... 24 V AC/DC ± 20 %

Retaining bracket - RIF-RH-1 - 2900953



Relay retaining bracket, with ejector function and holder for marking material, suitable for RIF-1 relay base, for 16 mm tall miniature power relay and solid-state relay

Phoenix Contact 2020 © - all rights reserved
<http://www.phoenixcontact.com>

PHOENIX CONTACT GmbH & Co. KG
Flachmarktstr. 8
32825 Blomberg
Germany
Tel. +49 5235 300
Fax +49 5235 3 41200
<http://www.phoenixcontact.com>