

Feed-through header - MSTBO 2,5/ 3-G1R KMGY - 2853763

Please be informed that the data shown in this PDF Document is generated from our Online Catalog. Please find the complete data in the user's documentation. Our General Terms of Use for Downloads are valid (<http://phoenixcontact.com/download>)



PCB headers, nominal cross section: 2.5 mm², color: light gray, nominal current: 12 A, rated voltage (III/2): 320 V, contact surface: Tin, type of contact: Male connector, Number of potentials: 3, Number of rows: 1, Number of positions per row: 3, number of connections: 3, product range: MSTBO 2,5/...-G1R, pitch: 5 mm, mounting: Wave soldering, pin layout: Linear pinning, solder pin [P]: 3.5 mm, Locking: without, type of packaging: packed in cardboard, Product with pin output on right side

Your advantages

- Headers for ME/ME MAX electronics housing
- 5 mm pitch
- Plug-in direction orthogonal to the PCB
- 2 to 4-pos.

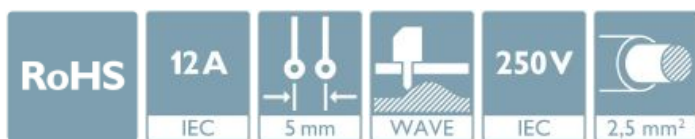

Key Commercial Data

Packing unit	50 pc
GTIN	 4 017918 450113
GTIN	4017918450113

Technical data

Item properties

Brief article description	Feed-through header
Type of contact	Male connector
Range of articles	MSTBO 2,5/ -G1R
Pitch	5 mm
Number of positions	3
Mounting type	Wave soldering
Pin layout	Linear pinning
Locking	without
Number of levels	1
Number of connections	3
Number of potentials	3

Electrical parameters

Feed-through header - MSTBO 2,5/ 3-G1R KMGY - 2853763

Technical data

Electrical parameters

Nominal current I_N	12 A
Nom. voltage	250 V
Rated voltage (III/3)	250 V
Rated voltage (III/2)	320 V
Rated voltage (II/2)	400 V
Rated surge voltage (III/3)	4 kV
Rated surge voltage (III/2)	4 kV
Rated surge voltage (II/2)	4 kV

Material data - contact

Note	WEEE/RoHS-compliant, free of whiskers according to IEC 60068-2-82/ JEDEC JESD 201
Contact material	Cu alloy
Surface characteristics	hot-dip tin-plated

Material data - housing

Housing color	light gray (7035)
Insulating material	PA
Insulating material group	I
CTI according to IEC 60112	600
Flammability rating according to UL 94	V0
Glow wire flammability index GWFI according to EN 60695-2-12	850
Glow wire ignition temperature GWIT according to EN 60695-2-13	775
Temperature for the ball pressure test according to EN 60695-10-2	125 °C

Dimensions for the product

Length [l]	14.65 mm
Width [w]	16.5 mm
Height [h]	14.95 mm
Pitch	5 mm
Solder pin [P]	3.5 mm
Pin dimensions	1 x 1 mm

Dimensions for PCB design

Hole diameter	1.4 mm
---------------	--------

Packaging information

Type of packaging	packed in cardboard
Pieces per package	50
Denomination packing units	Pcs.
Outer packaging type	Carton

Ambient conditions

Ambient temperature (storage/transport)	-40 °C ... 55 °C
---	------------------

Feed-through header - MSTBO 2,5/ 3-G1R KMGY - 2853763

Technical data

Ambient conditions

Ambient temperature (assembly)	-5 °C ... 100 °C
Ambient temperature (operation)	-40 °C ... 100 °C (dependent on the derating curve)

Air clearances and creepage distances

Standards and Regulations

Connection in acc. with standard	EN-VDE
	CSA

Environmental Product Compliance

China RoHS	Environmentally friendly use period: unlimited = EFUP-e
	No hazardous substances above threshold values

Drawings

Schematic diagram

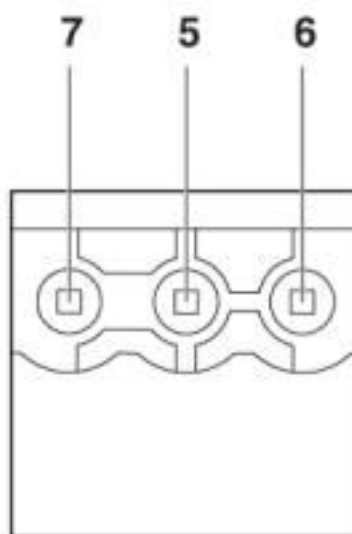
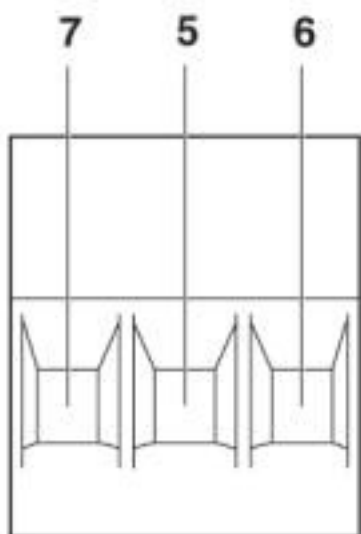

Pin assignment right

Classifications

eCl@ss

eCl@ss 10.0.1	27440402
eCl@ss 11.0	27460201
eCl@ss 4.0	27260700
eCl@ss 4.1	27260700
eCl@ss 5.0	27260700
eCl@ss 5.1	27260700
eCl@ss 6.0	27260700

Feed-through header - MSTBO 2,5/ 3-G1R KMGY - 2853763

Classifications

eCl@ss

eCl@ss 7.0	27440402
eCl@ss 8.0	27440402
eCl@ss 9.0	27440402

ETIM

ETIM 2.0	EC001031
ETIM 3.0	EC001031
ETIM 4.0	EC002637
ETIM 5.0	EC002637
ETIM 6.0	EC002637
ETIM 7.0	EC002637

UNSPSC

UNSPSC 6.01	30211801
UNSPSC 7.0901	39121432
UNSPSC 11	34131203
UNSPSC 12.01	39121432
UNSPSC 13.2	39121409
UNSPSC 18.0	39121409
UNSPSC 19.0	39121409
UNSPSC 20.0	39121409
UNSPSC 21.0	39121409

Approvals

Approvals

Approvals

CSA / IECCEB CB Scheme / EAC / cULus Recognized / VDE Zeichengenehmigung

Ex Approvals

Approval details

CSA		http://www.csagroup.org/services-industries/product-listing/	13631
	B	D	
Nominal voltage UN	300 V	300 V	
Nominal current IN	10 A	10 A	

Feed-through header - MSTBO 2,5/ 3-G1R KMGY - 2853763

Approvals

IECEE CB Scheme	CB scheme	http://www.iecee.org/	DE1-60988-B1B2
Nominal voltage UN		250 V	
Nominal current IN		8 A	

EAC	EAC	B.01687
-----	------------	---------

cULus Recognized	cULus	http://database.ul.com/cgi-bin/XYV/template/LISEXT/1FRAME/index.htm	E60425-20050718
Nominal voltage UN		300 V	300 V
Nominal current IN		16 A	10 A

VDE Zeichengenehmigung		http://www2.vde.com/de/Institut/Online-Service/VDE-gepruefteProdukte/Seiten/Online-Suche.aspx	40050648
Nominal voltage UN		250 V	
Nominal current IN		8 A	

Accessories

Accessories

Coding element

Coding section - CR MSTBO-G1 - 2199618

Coding section, inserted into the recess in the header or the inverted plug, red insulating material



Filler plug

Feed-through header - MSTBO 2,5/ 3-G1R KMGY - 2853763

Accessories

Accessories - MSTB-BL - 1755477



Keying cap, for forming sections, plugs onto header pin, green insulating material

Flange

Accessories - MSTB-BF - 1759981



Mounting flange, for fixing both ends of the header onto the PCB, green insulating material, with M 2 x 14 screws and nuts.

Necessary add-on products

Printed-circuit board connector - MSTBT 2,5/ 3-ST KMGY - 1971947



PCB connector, nominal cross section: 2.5 mm², color: light gray, nominal current: 12 A, rated voltage (III/2): 320 V, contact surface: Tin, type of contact: Female connector, Number of potentials: 3, Number of rows: 1, Number of positions per row: 3, number of connections: 3, product range: MSTBT 2,5/..-ST, pitch: 5 mm, connection method: Screw connection with tension sleeve, conductor/PCB connection direction: 0 °, pin layout: Linear pinning, Stecksystem: CLASSIC COMBICON, Locking: without, type of packaging: packed in cardboard

Printed-circuit board connector - PSPT 2,5/ 3-ST KMGY - 2202345



PCB connector, color: light gray, contact surface: Tin, Number of potentials: 3, Number of positions per row: 3, number of connections: 3, product range: PSPT 2,5/..-ST, pitch: 5 mm, type of packaging: packed in cardboard, Color of the spring lever: orange

Additional products

Printed-circuit board connector - TVFKC 1,5/ 3-ST - 1713842

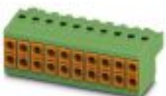

PCB connector, nominal cross section: 1.5 mm², color: green, nominal current: 10 A, rated voltage (III/2): 320 V, contact surface: Tin, type of contact: Female connector, Number of potentials: 3, Number of rows: 1, Number of positions per row: 3, number of connections: 6, product range: TVFKC 1,5/..-ST, pitch: 5 mm, connection method: Push-in spring connection, conductor/PCB connection direction: 0 °, Stecksystem: CLASSIC COMBICON, Locking: without, type of packaging: packed in cardboard

Feed-through header - MSTBO 2,5/ 3-G1R KMGY - 2853763

Accessories

Printed-circuit board connector - TVFKCL 1,5/ 3-ST - 1715934

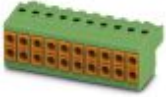

PCB connector, nominal cross section: 1.5 mm², color: green, nominal current: 10 A, rated voltage (III/2): 320 V, contact surface: Tin, type of contact: Female connector, Number of potentials: 3, Number of rows: 1, Number of positions per row: 3, number of connections: 6, product range: TVFKCL 1,5/..-ST, pitch: 5 mm, connection method: Push-in spring connection, conductor/PCB connection direction: 0 °, Stecksystem: CLASSIC COMBICON, Locking: without, type of packaging: packed in cardboard

Plug - QC 1,5/ 3-ST - 1717974

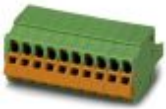

PCB connector, nominal cross section: 1.5 mm², color: green, nominal current: 12 A, rated voltage (III/2): 630 V, contact surface: Tin, type of contact: Female connector, Number of potentials: 3, Number of rows: 1, Number of positions per row: 3, number of connections: 3, product range: QC 1,5/..-ST, pitch: 5 mm, connection method: Displacement connection, conductor/PCB connection direction: 0 °, Stecksystem: CLASSIC COMBICON, Locking: without, type of packaging: packed in cardboard

Printed-circuit board connector - FKCN 2,5/ 3-ST - 1732755



PCB connector, nominal cross section: 2.5 mm², color: green, nominal current: 12 A, rated voltage (III/2): 320 V, contact surface: Tin, type of contact: Female connector, Number of potentials: 3, Number of rows: 1, Number of positions per row: 3, number of connections: 3, product range: FKCN 2,5/..-ST, pitch: 5 mm, connection method: Push-in spring connection, conductor/PCB connection direction: 0 °, Stecksystem: CLASSIC COMBICON, Locking: without, type of packaging: packed in cardboard

Printed-circuit board connector - MSTB 2,5/ 3-ST - 1754465



PCB connector, nominal cross section: 2.5 mm², color: green, nominal current: 12 A, rated voltage (III/2): 320 V, contact surface: Tin, type of contact: Female connector, Number of potentials: 3, Number of rows: 1, Number of positions per row: 3, number of connections: 3, product range: MSTB 2,5/..-ST, pitch: 5 mm, connection method: Screw connection with tension sleeve, conductor/PCB connection direction: 0 °, Stecksystem: CLASSIC COMBICON, Locking: without, type of packaging: packed in cardboard

Printed-circuit board connector - MSTBP 2,5/ 3-ST - 1765784



PCB connector, nominal cross section: 2.5 mm², color: green, nominal current: 12 A, rated voltage (III/2): 320 V, contact surface: Tin, type of contact: Female connector, Number of potentials: 3, Number of rows: 1, Number of positions per row: 3, number of connections: 3, product range: MSTBP 2,5/..-ST, pitch: 5 mm, connection method: Screw connection with tension sleeve, conductor/PCB connection direction: 0 °, Stecksystem: CLASSIC COMBICON, Locking: without, type of packaging: packed in cardboard

Feed-through header - MSTBO 2,5/ 3-G1R KMGY - 2853763

Accessories

Printed-circuit board connector - SMSTB 2,5/ 3-ST - 1768778



PCB connector, nominal cross section: 2.5 mm², color: green, nominal current: 12 A, rated voltage (III/2): 320 V, contact surface: Tin, type of contact: Female connector, Number of potentials: 3, Number of rows: 1, Number of positions per row: 3, number of connections: 3, product range: SMSTB 2,5/..-ST, pitch: 5 mm, connection method: Screw connection with tension sleeve, conductor/PCB connection direction: -45 °, Stecksystem: CLASSIC COMBICON, Locking: without, type of packaging: packed in cardboard

Printed-circuit board connector - FRONT-MSTB 2,5/ 3-ST - 1779424



PCB connector, nominal cross section: 2.5 mm², color: green, nominal current: 12 A, rated voltage (III/2): 320 V, contact surface: Tin, type of contact: Female connector, Number of potentials: 3, Number of rows: 1, Number of positions per row: 3, number of connections: 3, product range: FRONT-MSTB 2,5/..-ST, pitch: 5 mm, connection method: Front screw connection, conductor/PCB connection direction: 0 °, Stecksystem: CLASSIC COMBICON, Locking: without, type of packaging: packed in cardboard

Printed-circuit board connector - MSTBT 2,5/ 3-ST - 1779848



PCB connector, nominal cross section: 2.5 mm², color: green, nominal current: 12 A, rated voltage (III/2): 320 V, contact surface: Tin, type of contact: Female connector, Number of potentials: 3, Number of rows: 1, Number of positions per row: 3, number of connections: 3, product range: MSTBT 2,5/..-ST, pitch: 5 mm, connection method: Screw connection with tension sleeve, conductor/PCB connection direction: 0 °, Stecksystem: CLASSIC COMBICON, Locking: without, type of packaging: packed in cardboard

Printed-circuit board connector - MVSTBR 2,5/ 3-ST - 1792029



PCB connector, nominal cross section: 2.5 mm², color: green, nominal current: 12 A, rated voltage (III/2): 320 V, contact surface: Tin, type of contact: Female connector, Number of potentials: 3, Number of rows: 1, Number of positions per row: 3, number of connections: 3, product range: MVSTBR 2,5/..-ST, pitch: 5 mm, connection method: Screw connection with tension sleeve, conductor/PCB connection direction: 90 °, Stecksystem: CLASSIC COMBICON, Locking: without, type of packaging: packed in cardboard

Printed-circuit board connector - MVSTBW 2,5/ 3-ST - 1792537



PCB connector, nominal cross section: 2.5 mm², color: green, nominal current: 12 A, rated voltage (III/2): 320 V, contact surface: Tin, type of contact: Female connector, Number of potentials: 3, Number of rows: 1, Number of positions per row: 3, number of connections: 3, product range: MVSTBW 2,5/..-ST, pitch: 5 mm, connection method: Screw connection with tension sleeve, conductor/PCB connection direction: -90 °, Stecksystem: CLASSIC COMBICON, Locking: without, type of packaging: packed in cardboard

Feed-through header - MSTBO 2,5/ 3-G1R KMGY - 2853763

Accessories

Printed-circuit board connector - FKCT 2,5/ 3-ST - 1909223



PCB connector, nominal cross section: 2.5 mm², color: green, nominal current: 12 A, rated voltage (III/2): 320 V, contact surface: Tin, type of contact: Female connector, Number of potentials: 3, Number of rows: 1, Number of positions per row: 3, number of connections: 3, product range: FKCT 2,5/..-ST, pitch: 5 mm, connection method: Push-in spring connection, conductor/PCB connection direction: 0 °, Stecksystem: CLASSIC COMBICON, Locking: without, type of packaging: packed in cardboard

Printed-circuit board connector - FKCVR 2,5/ 3-ST - 1909728



PCB connector, nominal cross section: 2.5 mm², color: green, nominal current: 12 A, rated voltage (III/2): 320 V, contact surface: Tin, type of contact: Female connector, Number of potentials: 3, Number of rows: 1, Number of positions per row: 3, number of connections: 3, product range: FKCVR 2,5/..-ST, pitch: 5 mm, connection method: Push-in spring connection, conductor/PCB connection direction: 90 °, Stecksystem: CLASSIC COMBICON, Locking: without, type of packaging: packed in cardboard

Printed-circuit board connector - FKCVW 2,5/ 3-ST - 1910047



PCB connector, nominal cross section: 2.5 mm², color: green, nominal current: 12 A, rated voltage (III/2): 320 V, contact surface: Tin, type of contact: Female connector, Number of potentials: 3, Number of rows: 1, Number of positions per row: 3, number of connections: 3, product range: FKCVW 2,5/..-ST, pitch: 5 mm, connection method: Push-in spring connection, conductor/PCB connection direction: -90 °, Stecksystem: CLASSIC COMBICON, Locking: without, type of packaging: packed in cardboard

Printed-circuit board connector - FKC 2,5/ 3-ST - 1910364



PCB connector, nominal cross section: 2.5 mm², color: green, nominal current: 12 A, rated voltage (III/2): 320 V, contact surface: Tin, type of contact: Female connector, Number of potentials: 3, Number of rows: 1, Number of positions per row: 3, number of connections: 3, product range: FKC 2,5/..-ST, pitch: 5 mm, connection method: Push-in spring connection, conductor/PCB connection direction: 0 °, Stecksystem: CLASSIC COMBICON, Locking: without, type of packaging: packed in cardboard

Printed-circuit board connector - QC 1/ 3-ST-BUS - 1921683



PCB connector, nominal cross section: 1 mm², color: green, nominal current: 10 A, rated voltage (III/2): 630 V, contact surface: Tin, type of contact: Female connector, Number of potentials: 3, Number of rows: 1, Number of positions per row: 3, number of connections: 3, product range: QC 1/..-ST-BUS, pitch: 5 mm, connection method: Displacement connection, conductor/PCB connection direction: 90 °, Stecksystem: CLASSIC COMBICON, Locking: without, type of packaging: packed in cardboard, The plug allows conductors to be looped through from module to module, without interruption

Feed-through header - MSTBO 2,5/ 3-G1R KMGY - 2853763

Accessories

Printed-circuit board connector - FKCS 2,5/ 3-ST - 1974740



PCB connector, nominal cross section: 2.5 mm², color: green, nominal current: 12 A, rated voltage (III/2): 320 V, contact surface: Tin, type of contact: Female connector, Number of potentials: 3, Number of rows: 1, Number of positions per row: 3, number of connections: 3, product range: FKCS 2,5/..-ST, pitch: 5 mm, connection method: Push-in spring connection, conductor/PCB connection direction: 0 °, Stecksystem: CLASSIC COMBICON, Locking: without, type of packaging: packed in cardboard

Phoenix Contact 2020 © - all rights reserved
<http://www.phoenixcontact.com>

PHOENIX CONTACT GmbH & Co. KG
Flachsmarktstr. 8
32825 Blomberg
Germany
Tel. +49 5235 300
Fax +49 5235 3 41200
<http://www.phoenixcontact.com>