

Timer module - RIF-T3-24UC - 2902647

Please be informed that the data shown in this PDF Document is generated from our Online Catalog. Please find the complete data in the user's documentation. Our General Terms of Use for Downloads are valid (<http://phoenixcontact.com/download>)



Plug-in module for extending a relay module to create a timer relay, 3 time functions, 4 time ranges, for mounting on RIF-1, RIF-2, RIF-3, and RIF-4, input voltage: 12 ... 24 V DC



Key Commercial Data

Packing unit	1 pc
GTIN	
GTIN	4046356668880

Technical data

Note

Utilization restriction	EMC: class A product, see manufacturer's declaration in the download area
-------------------------	---

Dimensions

Width	13 mm
Height	12 mm
Depth	35 mm

Ambient conditions

Ambient temperature (operation)	-25 °C ... 50 °C (RIF-1, AC coil, 2 PDTs at 6 A)
	-25 °C ... 50 °C (RIF-1, DC coil, 2 PDTs at 5 A)
	-25 °C ... 40 °C (RIF-2, DC coil, 2 PDTs at 8 A)
	-25 °C ... 40 °C (RIF-2, DC coil, 4 PDTs at 5 A)
	-25 °C ... 40 °C (RIF-3, DC coil, 3 PDTs at 6.75 A)
	-25 °C ... 40 °C (RIF-3, DC coil, 2 PDTs at 8 A)
	-25 °C ... 35 °C (RIF-4, DC coil, 3 PDTs at 8 A)
	-25 °C ... 25 °C (RIF-4, DC coil, 3 N/O contacts at 8 A)
Ambient temperature (storage/transport)	-25 °C ... 85 °C

Timer module - RIF-T3-24UC - 2902647

Technical data

Input data

Nominal input voltage U_N	24 V DC (AC operation only permitted for RIF-1)
Input voltage range in reference to U_N	0.4 ... 1.2
Mains frequency	50 Hz 60 Hz
Status display	Yellow LED
Protective circuit/component	Varistor
Surge voltage protection	> 56 V

Output data

Limiting continuous current	≤ 250 mA (Relay coil current)
Voltage drop at max. limiting continuous current	< 100 mV

General

Setting accuracy	3 % (of scale end value)
Repeat accuracy	1 %
Insulation	Basic insulation
Standards/regulations	DIN EN 50178
Mounting position	any
Assembly instructions	Can be inserted into relay base

Standards and Regulations

Connection in acc. with standard	CSA
Designation	Air clearances and creepage distances in a circuit
Standards/regulations	DIN EN 50178
Rated insulation voltage	50 V DC
Rated surge voltage	0.4 kV
Insulation	Basic insulation
Pollution degree	2
Overvoltage category	I

Environmental Product Compliance

China RoHS	Environmentally Friendly Use Period = 50 years
	For details about hazardous substances go to tab "Downloads", Category "Manufacturer's declaration"

Drawings

Timer module - RIF-T3-24UC - 2902647

Diagram

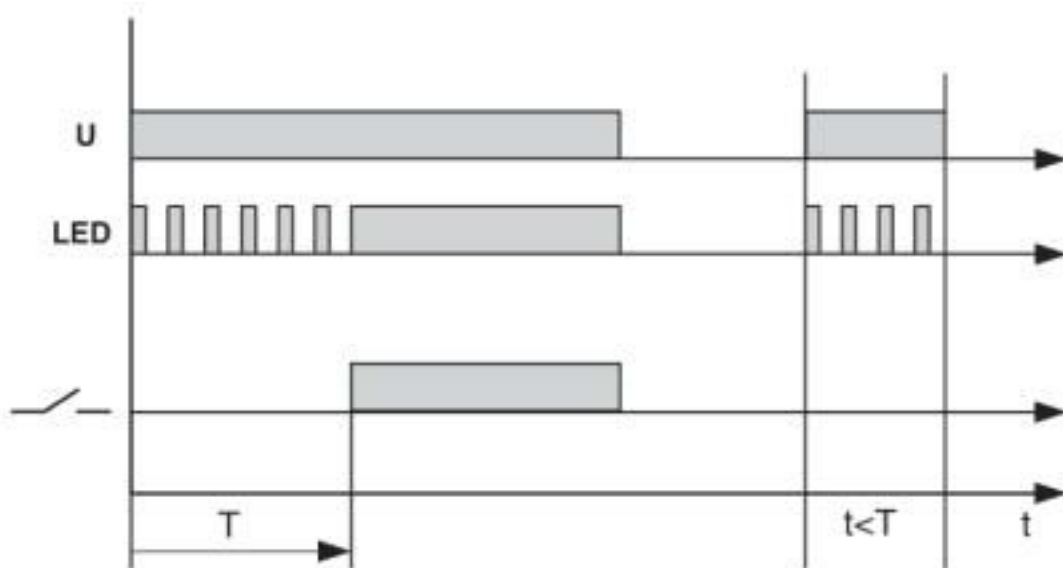

With switch-on delay

Diagram

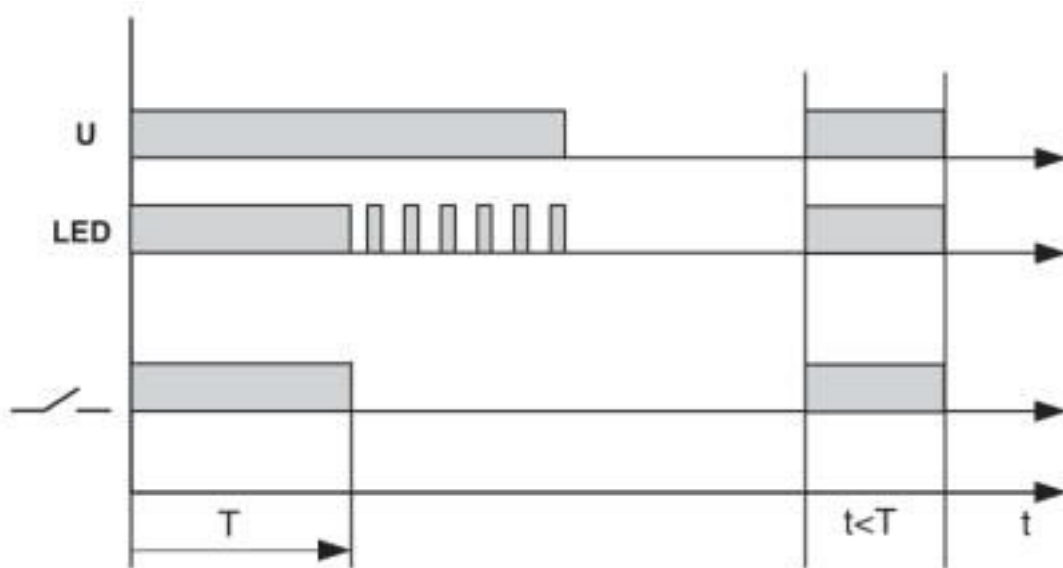

With passing make contact

Timer module - RIF-T3-24UC - 2902647

Diagram

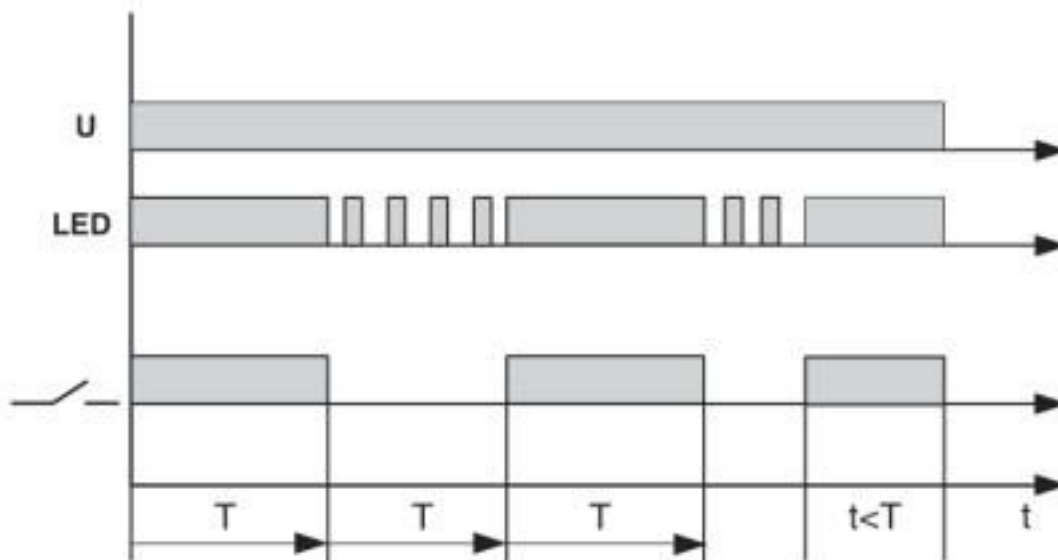

Flasher/pulse generator

Circuit diagram

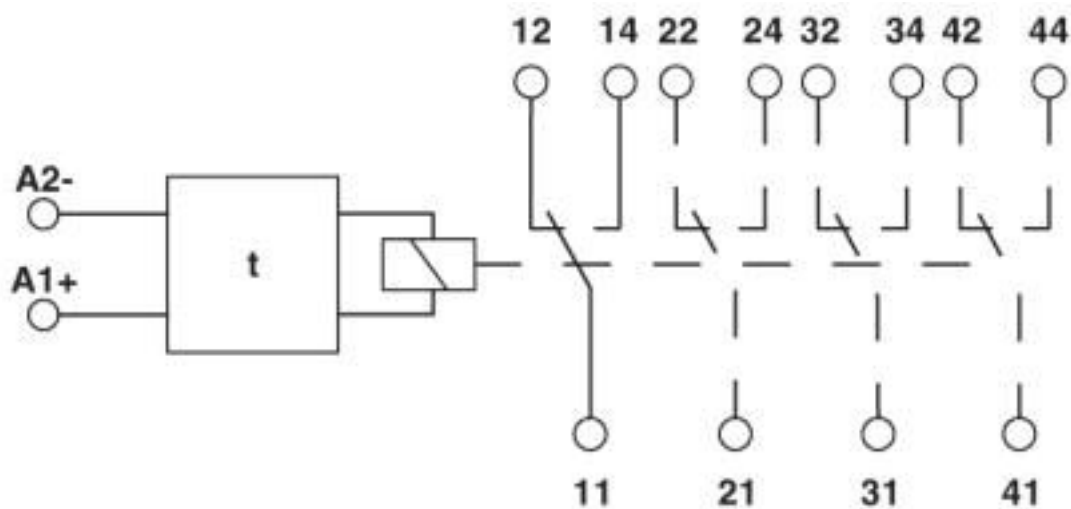

Classifications

eCl@ss

eCl@ss 10.0.1	27371692
eCl@ss 11.0	27371692
eCl@ss 4.0	27371100
eCl@ss 4.1	27371100
eCl@ss 5.0	27371600
eCl@ss 5.1	27371600

Timer module - RIF-T3-24UC - 2902647

Classifications

eCl@ss

eCl@ss 6.0	27379200
eCl@ss 7.0	27379208
eCl@ss 8.0	27379208
eCl@ss 9.0	27371692

ETIM

ETIM 4.0	EC002586
ETIM 5.0	EC002586
ETIM 6.0	EC002586
ETIM 7.0	EC002586

UNSPSC

UNSPSC 6.01	30211917
UNSPSC 7.0901	39121516
UNSPSC 11	39121516
UNSPSC 12.01	39121516
UNSPSC 13.2	39121516
UNSPSC 18.0	39122335
UNSPSC 19.0	39122335
UNSPSC 20.0	39122335
UNSPSC 21.0	39122335

Approvals

Approvals

Approvals

DNV GL / CSA / PRS / LR / UL Recognized / EAC / DNV GL

Ex Approvals





Approval details

DNV GL		https://approvalfinder.dnvgl.com/	TAA000018V
--------	---	---	------------

CSA		http://www.csagroup.org/services-industries/product-listing/	2607057
-----	---	---	---------

Timer module - RIF-T3-24UC - 2902647

Approvals

PRS		http://www.prs.pl/	TE/2108/880590/16
LR		http://www.lr.org/en	15/20011
UL Recognized		http://database.ul.com/cgi-bin/XYV/template/LISEXT/1FRAME/index.htm	FILE E 113228
EAC			RU*DE.*08.B.01536/19
DNV GL		https://approvalfinder.dnvgl.com/	TAA000018V

Phoenix Contact 2020 © - all rights reserved
<http://www.phoenixcontact.com>

PHOENIX CONTACT GmbH & Co. KG
Flachsmarktstr. 8
32825 Blomberg
Germany
Tel. +49 5235 300
Fax +49 5235 3 41200
<http://www.phoenixcontact.com>