

# String combiner box (SCB) - SOL-SC-1ST-0-DC-6MPPT-1001SE - 1022360

Please be informed that the data shown in this PDF Document is generated from our Online Catalog. Please find the complete data in the user's documentation. Our General Terms of Use for Downloads are valid (<http://phoenixcontact.com/download>)



String combiner box for photovoltaic systems up to 1000 V DC for the connection of 6x 1 string. With surge protection and SUNCLIX DC connector for the input and output side.

## Product Description

The Solarline string combiner boxes (SCBs) are used in both small rooftop systems and large ground-mounted systems. Their functions include collecting and protecting strings and, if necessary, separating the panels from the rest of the system by means of a switch disconnecter or fire service switch disconnecter.

## Your advantages

- Fast installation and startup
- Large portfolio of string combiner boxes in stock
- Application-oriented consultation
- Standard-compliant switchgear and controlgear assembly, thanks to use of DIN EN 61439



## Key Commercial Data

Packing unit	1 pc
GTIN	
GTIN	4055626515939

## Technical data

### System parameter

System voltage	1000 V DC ( $U_{max}$ )
Number of string inputs	1 (per MPP tracker)
Current per string (max.)	40 A ( $I_{max}$ )
Number of outputs	1 (per MPP tracker)
Number of supported MPP trackers	6

### Safety equipment

Surge protective device	T1 / T2
-------------------------	---------

## String combiner box (SCB) - SOL-SC-1ST-0-DC-6MPPT-1001SE - 1022360

### Technical data

#### Safety equipment

Protection level $U_p$	$\leq 3.5$ kV
Total discharge current $I_{total}$ (8/20) $\mu$ s	40 kA
Total discharge current $I_{total}$ (10/350) $\mu$ s	5 kA

#### Cable entry

Type of cable entry	SUNCLIX
Cable cross section string input	2.5 mm <sup>2</sup> ... 6 mm <sup>2</sup>
Cable cross section output	2.5 mm <sup>2</sup> ... 6 mm <sup>2</sup>
Cable cross section grounding	16 mm <sup>2</sup> (2x)
Sealing area grounding	6 mm ... 12 mm (2x)

#### General data

Material cover/door	Polycarbonate (transparent)
Housing material	Polycarbonate
Degree of protection	IP65
Protection class	II

#### Dimensions

Outer dimensions: width, height, depth	361 mm x 254 mm x 111 mm (Housing dimensions)
--	---

#### Ambient conditions

Ambient temperature (operation)	-20 °C ... 55 °C
---------------------------------	------------------

### Drawings

# String combiner box (SCB) - SOL-SC-1ST-0-DC-6MPPT-1001SE - 1022360

Schematic diagram



Connection of the protective grounding conductor

Schematic diagram



Connection of the protective equipotential bonding conductor

# String combiner box (SCB) - SOL-SC-1ST-0-DC-6MPPT-1001SE - 1022360

Connection diagram

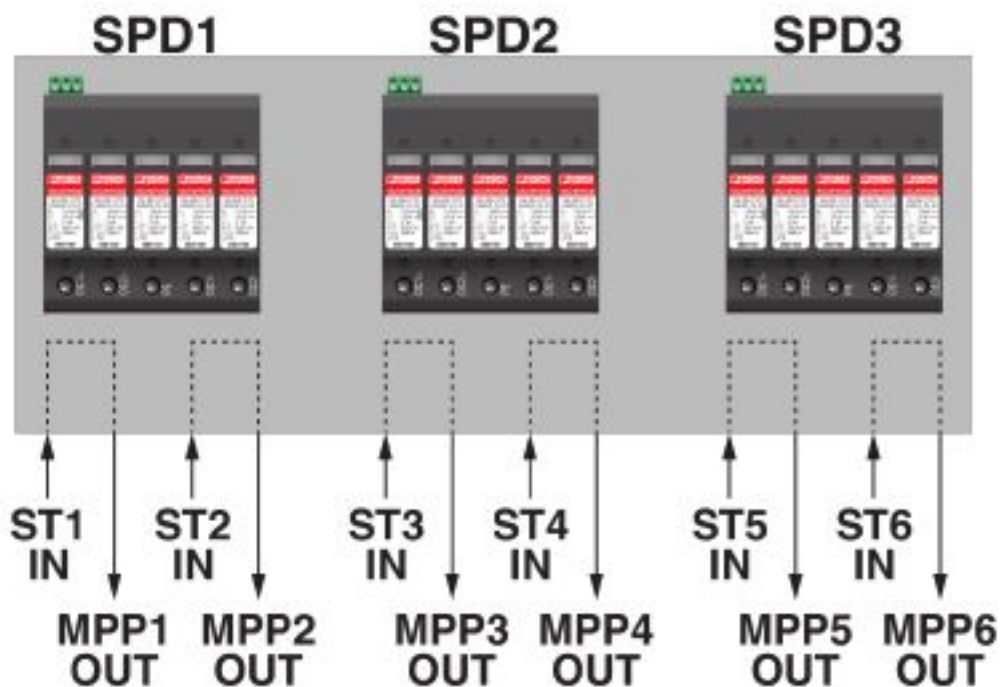

Schematic application drawing

Dimensional drawing

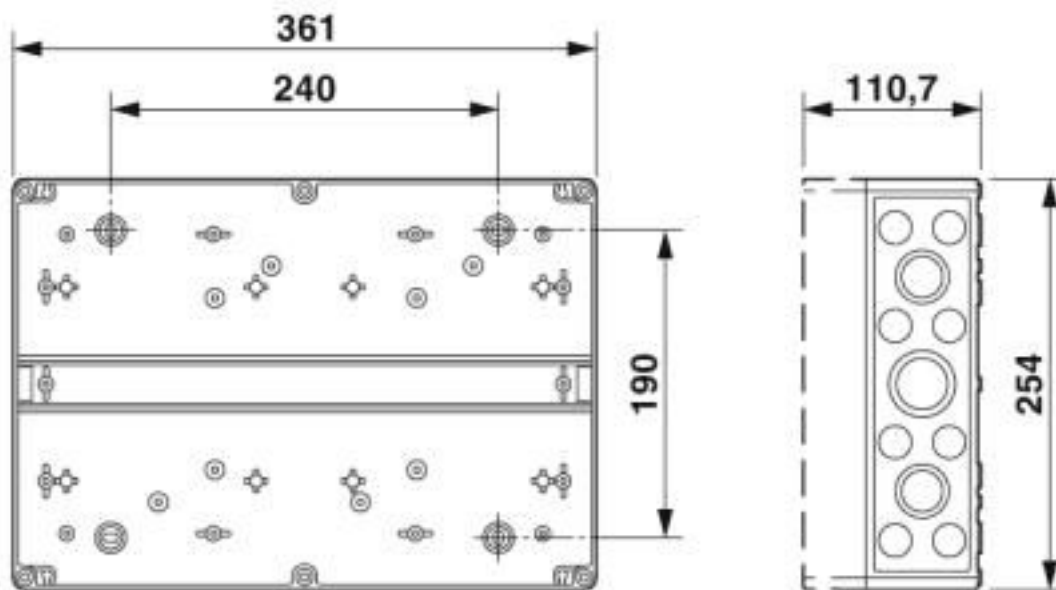

Housing dimensions

# String combiner box (SCB) - SOL-SC-1ST-0-DC-6MPPT-1001SE - 1022360

Circuit diagram

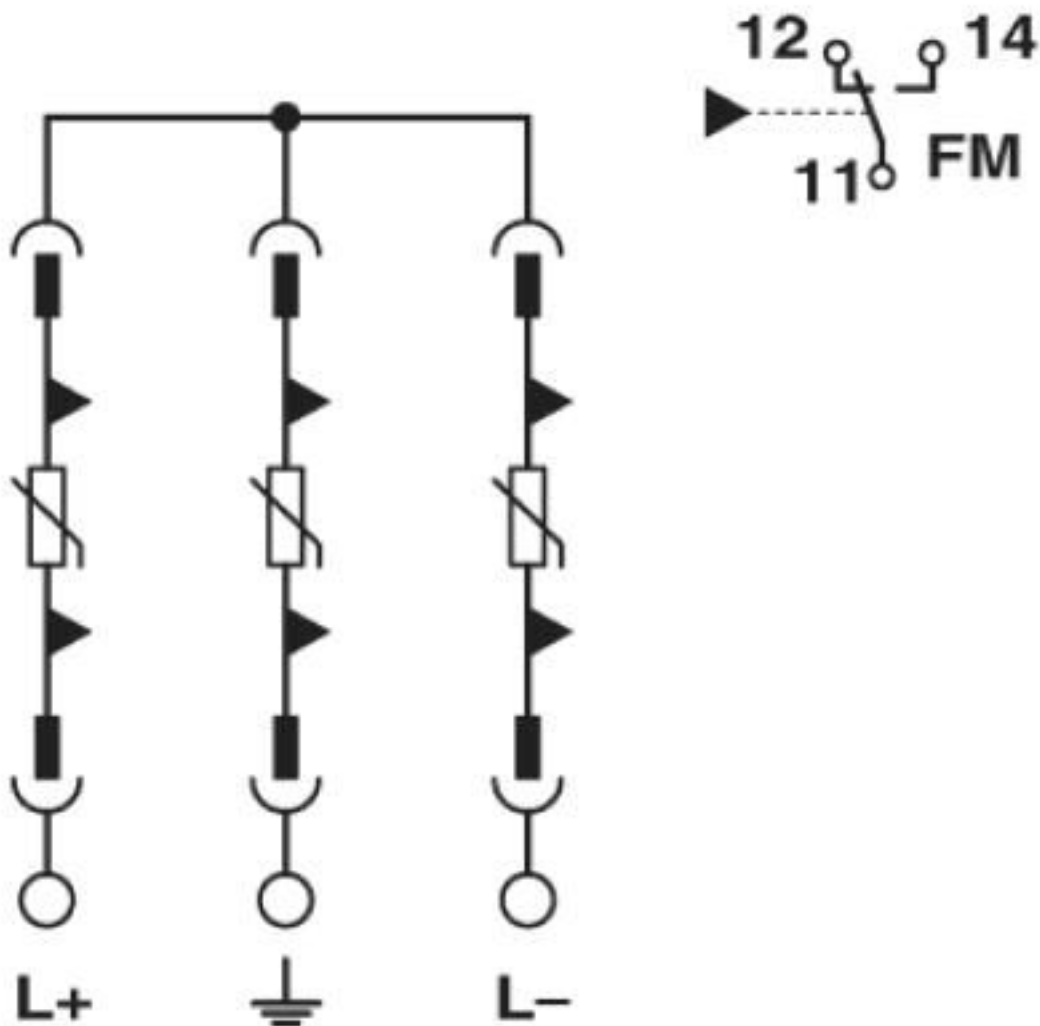

Connection of the remote indication contact on the surge protection

# String combiner box (SCB) - SOL-SC-1ST-0-DC-6MPPT-1001SE - 1022360

Schematic diagram

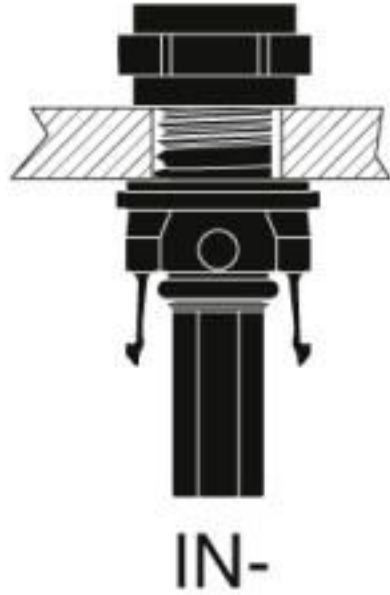
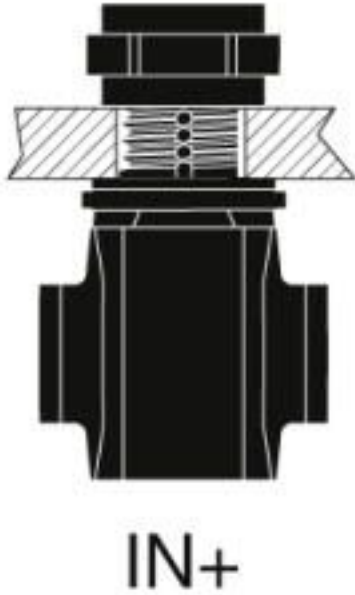

Connection of the PV strings

Schematic diagram

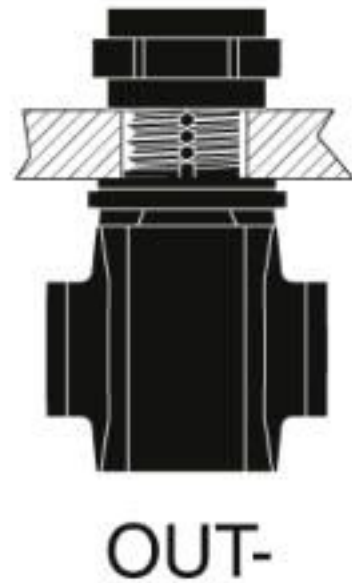
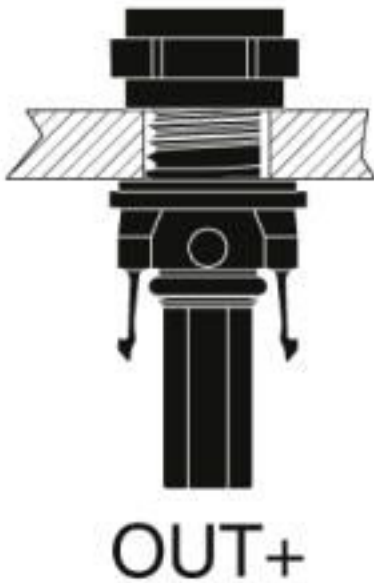

Connection to the inverter

# String combiner box (SCB) - SOL-SC-1ST-0-DC-6MPPT-1001SE - 1022360

## Classifications

eCl@ss

eCl@ss 10.0.1	27142422
eCl@ss 11.0	27142422
eCl@ss 5.1	27371890
eCl@ss 7.0	27142422
eCl@ss 8.0	27142422
eCl@ss 9.0	27142422

ETIM

ETIM 4.0	EC000816
ETIM 5.0	EC000268
ETIM 6.0	EC000268
ETIM 7.0	EC000268

## Accessories

### Accessories

#### Photovoltaic connector

Protective cap - PV-C PROTECTION CAP - 1785430

Photovoltaic connector, Range of articles: SUNCLIX, Protective cap, color: black. self-sealing, without interlock, set consisting of: 1 protective cap for connector side and 1 protective cap for coupling side



Connector - PV-CF-S 2,5-6 (+) - 1774674



Photovoltaic connector, Range of articles: PV-CF-S, Connector, housing material: PPE, color: black, number of positions: 1, min. conductor cross section: 2.5 mm<sup>2</sup>, max. conductor cross section: 6 mm<sup>2</sup>, rated current: 27 A, Connection method: Spring-cage, Type of contact: Socket

Connector - PV-CM-S 2,5-6 (-) - 1774687



Photovoltaic connector, Range of articles: PV-CM-S, Connector, housing material: PPE, color: black, number of positions: 1, min. conductor cross section: 2.5 mm<sup>2</sup>, max. conductor cross section: 6 mm<sup>2</sup>, rated current: 27 A, Connection method: Spring-cage, Type of contact: Pin

## String combiner box (SCB) - SOL-SC-1ST-0-DC-6MPPT-1001SE - 1022360

### Accessories

Photovoltaic Y-distributor - PV-ED6/Y-120(2+/1-) - 1030649

Photovoltaic connector, Photovoltaic Y-distributor, housing material: PPE, color: black



Connector - PV-CF-S 6-16 (+) - 1790784



Photovoltaic connector, Range of articles: PV-CF-S, Connector, housing material: PPE, color: black, number of positions: 0, min. conductor cross section: 6 mm<sup>2</sup>, max. conductor cross section: 16 mm<sup>2</sup>, rated current: 40 A, Connection method: Spring-cage, Type of contact: Socket

Photovoltaic Y-distributor - PV-ED6/Y-120(1+/2-) - 1030650

Photovoltaic connector, Photovoltaic Y-distributor, housing material: PPE, color: black



Connector - PV-CM-S 6-16 (-) - 1790797



Photovoltaic connector, Range of articles: PV-CM-S, Connector, housing material: PPE, color: black, number of positions: 0, min. conductor cross section: 6 mm<sup>2</sup>, max. conductor cross section: 16 mm<sup>2</sup>, rated current: 40 A, Connection method: Spring-cage, Type of contact: Pin

Photovoltaic adapter set - PV-AS-MC4/6-150-MN-SET1 - 1079531



Photovoltaic connector, Photovoltaic adapter set, type: Adapter, color: black, rated current: 35 A, cable length: 150. Connect these connectors only to other connectors of the same type made by the same manufacturer. When making the connections, always observe the specifications regarding nominal voltage and nominal current. The smallest common value is permissible.

Replacement plug

## String combiner box (SCB) - SOL-SC-1ST-0-DC-6MPPT-1001SE - 1022360

### Accessories

Type 1/2 surge protection plug - VAL-MS-T1/T2 1000DC-PV-ST - 2801162



Replacement plug for PV arrester combinations from the VAL-MS-T1/T2 1000DC-PV-... product range

---

### Tool set

Tool set - TOOL-KIT SOLAR - 1212071



Tool case, equipped with: crimping pliers, pressing dies for MC3, MC4 and SOLARLOK connectors, stripping tool for commercially available solar cables, stripping tool for SUNCLIX, VDE cable cutter, VDE screwdriver: PH1, PH2, 0.6x3.5 and 0.8x4.0 slots.

---

Phoenix Contact 2020 © - all rights reserved  
<http://www.phoenixcontact.com>

PHOENIX CONTACT GmbH & Co. KG  
Flachsmarktstr. 8  
32825 Blomberg  
Germany  
Tel. +49 5235 300  
Fax +49 5235 3 41200  
<http://www.phoenixcontact.com>